

# 世界トップレベルの品揃えと SMD の組み立てやすさで あらゆる電子機器に展開できる CITILED

Featuring world-class product variations and ease of SMD assembly.  
Ultra-small Chip-LEDs for use in various electronic products.



情報通信機器の小型化・高性能化が進む中で、チップ型 LED へのニーズは急速に伸びています。この領域において当社の CITILED（登録商標）は、装着のオートメーション化が可能な SMD（表面実装）タイプとして、コストダウンに大きく貢献します。また、充実した品揃えやフレキシブルな納入方法によってお客様のニーズに的確にお応えし、生産量において世界トップシェアを実現しています。

As information devices become ever more compact and sophisticated, the demand for chip-type LEDs has accelerated drastically. Citizen has this field covered as well, with its series of CITILED (Citizen trademark) products. These SMD type LEDs allow automated mounting, thereby reducing production costs. The flexible lineup contains products suitable for every need, making Citizen the leading manufacturer worldwide in this sector.

## ■ 特徴 / Features

1. 全機種 SMD(表面実装デバイス) タイプの LED ランプです。
2. 寸法は標準型から極小型、超小型まで各種を取り揃えており、高密度実装が可能です。
3. 全機種に標準タイプ、高輝度タイプ、超高輝度タイプがあります。
4. 全ての CITILED 製品は、チップマウンターによる自動マウントが可能で高い装着率が得られます。
5. 全ての CITILED はリフローはんだが可能です。
6. バルクやテーピングの納入をはじめ、基板にアッセンブリしたユニットでの納入にもお応えします。
7. 全ての CITILED 製品は、鉛フリー対応製品です。

1. All are SMD(surface mount device) LED lamps.
2. Varieties range from the standard to very small and ultra-small sizes and high density mounting is available.
3. There are standard brightness type, super brightness type and ultra brightness type.
4. Automated chip machine mounting allows for efficient mounting.
5. Reflow soldering is available.
6. Shippable in bulk, on tape and mounted as an assembly.
7. All CITILED are lead free correspondence products.

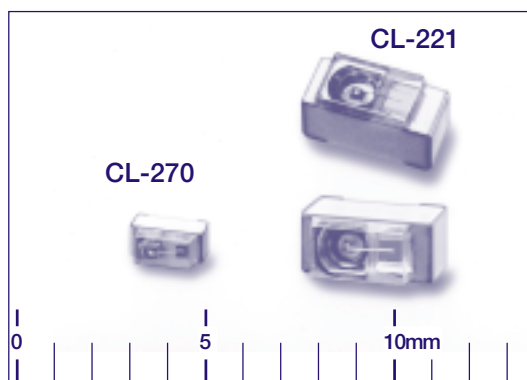

## ■ 用途 / Application

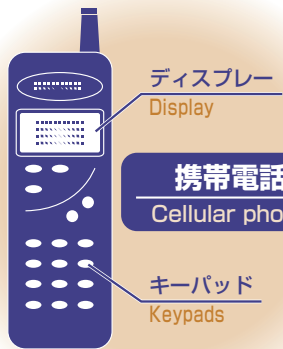

**携帯電話**  
Cellular phone

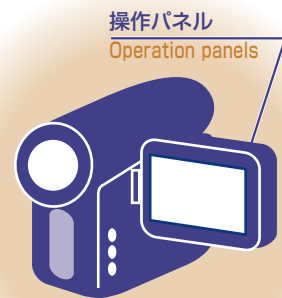

**ビデオカメラ**  
Video camera

操作パネル  
Operation panels

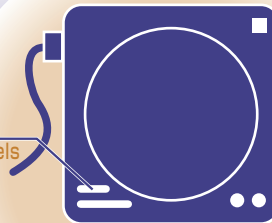

**携帯型オーディオ機器**  
Portable audio products

操作パネル  
Operation panels

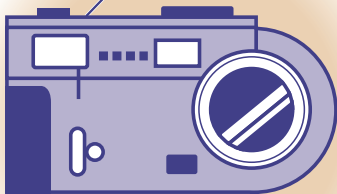

**デジタルカメラ**  
Digital still camera

表示用発光体  
Lighting device for display



**大型ディスプレイ**  
Large display

スキャナー光源  
Light source for scanners

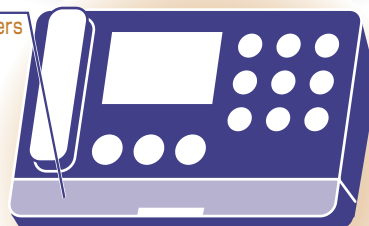

**FAX用ハンディスキャナー**  
Facsimile machine handheld scanners

# 製品構成 / Composition of Products

## 上面発光・表面実装

Upward-lightning and surface mountable type

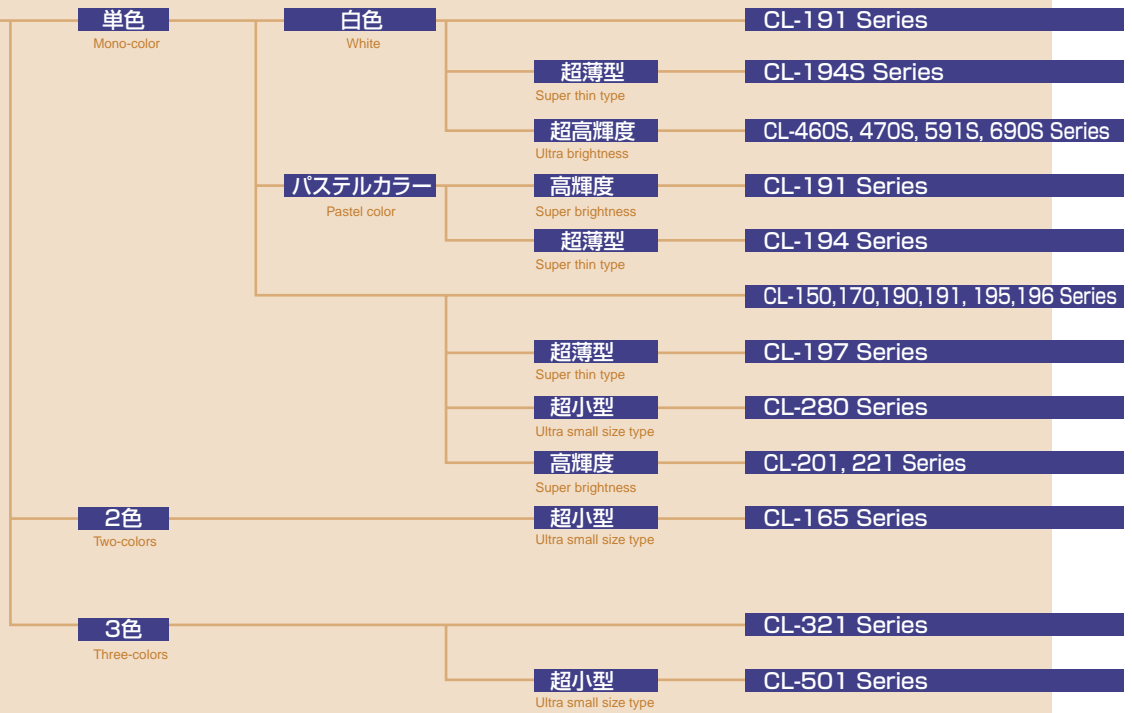

## 側面発光・表面実装

Side-lighting and surface mountable type

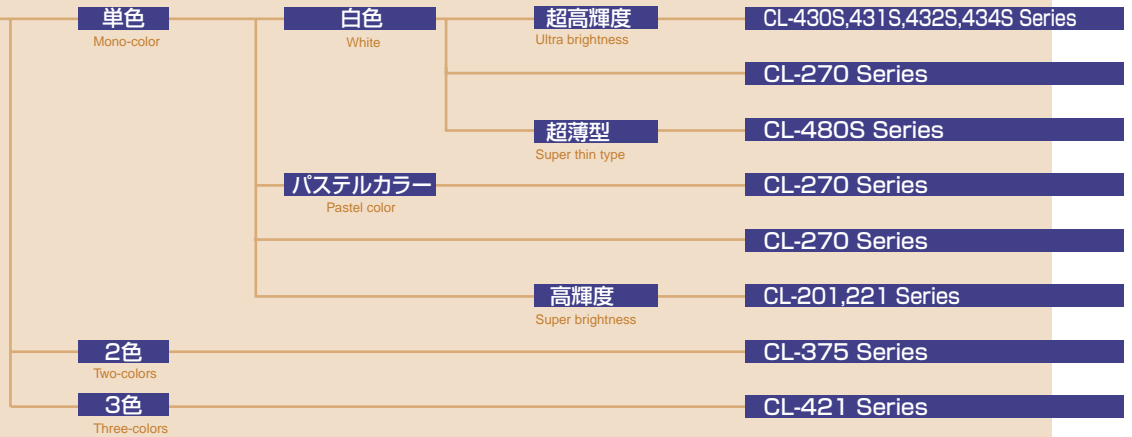

## 上面発光・裏面実装

Upward-lightning type but mountable from bottom side of PCB

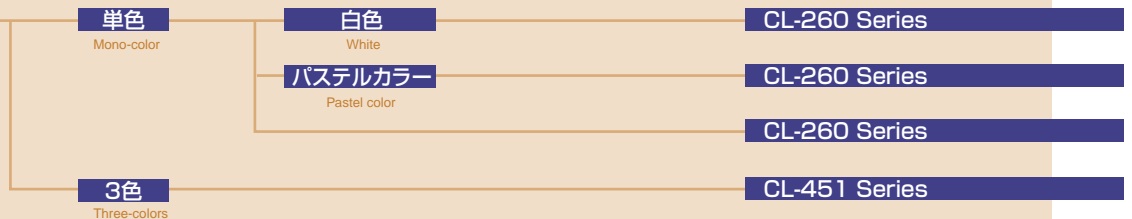

## ●部品コード / Code for Parts

CL - 150 R - C D - T

### シリーズ / Series

CL-150 : 単色発光 / Mono-color    CL-201 : 単色発光 / Mono-color    CL-432S : 単色発光 / Mono-color  
 CL-165 : 2色発光 / Two-colors    CL-221 : 単色発光 / Mono-color    CL-434S : 単色発光 / Mono-color  
 CL-170 : 単色発光 / Mono-color    CL-260 : 単色発光 / Mono-color    CL-451 : 3色発光 / Three-colors  
 CL-190 : 単色発光 / Mono-color    CL-270 : 単色発光 / Mono-color    CL-460S : 単色発光 / Mono-color  
 CL-191 : 単色発光 / Mono-color    CL-280 : 単色発光 / Mono-color    CL-470S : 単色発光 / Mono-color  
 CL-194 : 単色発光 / Mono-color    CL-321 : 3色発光 / Three-colors    CL-480S : 単色発光 / Mono-color  
 CL-194S : 単色発光 / Mono-color    CL-375 : 2色発光 / Two-colors    CL-501 : 3色発光 / Three-colors  
 CL-195 : 単色発光 / Mono-color    CL-421 : 3色発光 / Three-colors    CL-591S : 単色発光 / Mono-color  
 CL-196 : 単色発光 / Mono-color    CL-430S : 単色発光 / Mono-color    CL-690S : 単色発光 / Mono-color  
 CL-197 : 単色発光 / Mono-color    CL-431S : 単色発光 / Mono-color

### 発光色 / Lighting color

#### 【標準輝度 / Standard brightness】

R:赤 / Red    D:橙 / Orange    Y:黄 / Yellow    YG:黄緑 / Yellow green  
 G:緑 / Green    FG:新緑 / Fresh green    PG:純緑 / Pure green

#### 【高輝度 / Super brightness】

UR:赤 / Ultra brightness red    SR:赤 / Super brightness red    SD:橙 / Super brightness Orange  
 SYG:黄緑 / Super brightness yellow green    BG1:青緑 / High brightness blue green  
 HB1:青 / High brightness blue

#### 【超高輝度 / Ultra brightness】

HR:赤 / High brightness red    TR1:赤 / Top High brightness red  
 TD3:橙 / Top High brightness orange    TLY:黄 / Top High brightness lemon yellow  
 MG:緑 / Much High brightness green    MB:青 / Much High brightness blue  
 PS:パステルカラー / Pastel color    WB,WD,WE,WF,WH,WK,WL:白色 / White

### 樹脂色 / Color of resin

C : 着色(標準品) / Colored (standard)    X : 透明 / Transparent

### 散乱 / Diffusion

D : 散乱剤入(標準品) / Diffused (standard)    無記入 : 散乱剤なし / Non-coded : Not diffused

### 納入形態 / Packing mode

無記入 : バルク / Non-coded : Bulk packing    T : テーピング / T : Taping

CL-201,CL-221 の場合 TU : 上面テーピング TS : 側面テーピング





/In case of CL-201,CL-221 TU : Taping upward TS : Taping sideways

CL-260,CL-451 の場合 TD : 下面テーピング /In case of CL-260,CL-451 TD : Taping downward



CL-270,CL-375,CL-421,CL-430S,CL-431S,CL-432S,CL-434S,CL-480S の場合 TS : 側面テーピング /In case of CL-270,

CL-375,CL-421,CL-430S,CL-431S,CL-432S,CL-434S,CL-480S TS : Taping sideways

# ● CITILED セレクションガイド / CITILED Selection Guide



Series	Brightness	Lighting color	ピーク発光波長 Peak wave length (nm)	Code for parts	鉛フリー Lead free	Page	Series	Brightness	Lighting color	ピーク発光波長 Peak wave length (nm)	Code for parts	鉛フリー Lead free	Page
CL-150  3.2(L) × 1.6(w) × 1.1(H)	標準輝度 Standard brightness	赤 Red	700	CL-150R-CD	○	55	CL-191  1.6(L) × 0.8(W) × 0.6(H)	標準輝度 Standard brightness	赤 Red	700	CL-191R-CD	○	52
		橙 Orange	605	CL-150D-CD		55			橙 Orange	605	CL-191D-CD		52
		黄 Yellow	589	CL-150Y-CD		55			黄 Yellow	589	CL-191Y-CD		52
		黄緑 Yellow green	570	CL-150YG-CD		55			黄緑 Yellow green	570	CL-191YG-CD		52
		緑 Green	567	CL-150G-CD		55			緑 Green	567	CL-191G-CD		52
		新緑 Fresh green	560	CL-150FG-CD		55			新緑 Fresh green	560	CL-191FG-CD		52
		純緑 Pure green	557	CL-150PG-CD		55			純緑 Pure green	557	CL-191PG-CD		52
	高輝度 Super brightness	赤 Red	650	CL-150SR-CD		55		高輝度 Super brightness	赤 Red	650	CL-191SR-CD		52
		橙 Orange	630	CL-150SD-CD		55		橙 Orange	630	CL-191SD-CD	52		
		超高輝度 Ultra brightness	赤 Red	660		CL-150UR-CD		55	超高輝度 Ultra brightness	赤 Red	660		CL-191UR-CD
超高輝度 High brightness	赤 Red	660	CL-150HR-CD	55									
CL-170  2.0(L) × 1.25(w) × 1.1(H)	標準輝度 Standard brightness	赤 Red	700	CL-170R-CD	○	54	CL-194  1.6(L) × 0.8(W) × 0.3(H)	超高輝度 High brightness	赤 Red	660	CL-191HR-CD	○	52
		橙 Orange	605	CL-170D-CD		54			赤 Red	624	CL-191TR1-CD		26
		黄 Yellow	589	CL-170Y-CD		54			橙 Orange	612	CL-191TD3-CD		26
		黄緑 Yellow green	570	CL-170YG-CD		54			黄緑 Yellow green	574	CL-191SYG-CD		26
		緑 Green	567	CL-170G-CD		54			緑 Green	515	CL-191S-MG-D		24
		新緑 Fresh green	560	CL-170FG-CD		54			青緑 Blue green	502	CL-191BG1-C		24
		純緑 Pure green	557	CL-170PG-CD		54			青 Blue	470	CL-191HB1		24
	高輝度 Super brightness	赤 Red	650	CL-170SR-CD		54			青 Blue	470	CL-191S-MB-D		24
		橙 Orange	630	CL-170SD-CD		54							
		超高輝度 Ultra brightness	赤 Red	660		CL-170UR-CD			54				
超高輝度 High brightness	赤 Red	660	CL-170HR-CD	54									
CL-190  1.6(L) × 0.8(W) × 0.8(H)	標準輝度 Standard brightness	赤 Red	700	CL-190R-CD	○	53							
		橙 Orange	605	CL-190D-CD		53							
		黄 Yellow	589	CL-190Y-CD		53							
		黄緑 Yellow green	570	CL-190YG-CD		53							
		緑 Green	567	CL-190G-CD		53							
		新緑 Fresh green	560	CL-190FG-CD		53							
		純緑 Pure green	557	CL-190PG-CD		53							
	高輝度 Super brightness	赤 Red	650	CL-190SR-CD		53							
		橙 Orange	630	CL-190SD-CD		53							
		超高輝度 Ultra brightness	赤 Red	660		CL-190UR-CD	53						
超高輝度 High brightness	赤 Red	660	CL-190HR-CD	53									

※ パッケージの色については未量産の機種もございますので、ご使用の際にはご確認願います。  
 ※ Some package colors are not mass produced, so please check at the time of use.



Series	Brightness	Lighting color	ピーク発光波長 Peak wave length (nm)	Code for parts	鉛フリー Lead free	Page
<b>CL-195</b>  1.6(L) × 0.8(W) × 0.8(H)	標準輝度 Standard brightness	赤 Red	700	CL-195R-CD	○	51
		橙 Orange	605	CL-195D-CD		51
		黄 Yellow	589	CL-195Y-CD		51
		黄緑 Yellow green	570	CL-195YG-CD		51
		緑 Green	567	CL-195G-CD		51
		新緑 Fresh green	560	CL-195FG-CD		51
		純緑 Pure green	557	CL-195PG-CD		51
	高輝度 Super brightness	赤 Red	650	CL-195SR-CD		51
		橙 Orange	630	CL-195SD-CD		51
	超高輝度 Ultra brightness	赤 Red	660	CL-195UR-CD		51
	超高輝度 High brightness	赤 Red	660	CL-195HR-CD		51
	<b>CL-196</b>  1.6(L) × 0.8(w) × 0.6(H)	標準輝度 Standard brightness	赤 Red	700		CL-196R-CD
橙 Orange			605	CL-196D-CD	50	
黄 Yellow			589	CL-196Y-CD	50	
黄緑 Yellow green			570	CL-196YG-CD	50	
緑 Green			567	CL-196G-CD	50	
新緑 Fresh green			560	CL-196FG-CD	50	
純緑 Pure green			557	CL-196PG-CD	50	
高輝度 Super brightness		赤 Red	650	CL-196SR-CD	50	
		橙 Orange	630	CL-196SD-CD	50	
超高輝度 Ultra brightness		赤 Red	660	CL-196UR-CD	50	
超高輝度 High brightness		赤 Red	660	CL-196HR-CD	50	
<b>CL-197</b>  1.6(L) × 0.8(w) × 0.4(H)		標準輝度 Standard brightness	黄緑 Yellow green	570	CL-197YG-CD	○
	超高輝度 High brightness	青 Blue	470	CL-197HB1	○	24







※ パッケージの色については未量産の機種もございますので、ご使用の際にはご確認願います。

※ Some package colors are not mass produced, so please check at the time of use.

Series	Brightness	Lighting color	ピーク発光波長 Peak wave length (nm)	Code for parts	鉛フリー Lead free	Page
<b>CL-201</b>  3.2(L) × 2.4(W) × 2.4(H)	標準輝度 Standard brightness	赤 Red	700	CL-201R-C	○	48
		橙 Orange	605	CL-201D-C		48
		黄 Yellow	589	CL-201Y-C		48
		黄緑 Yellow green	570	CL-201YG-C		48
		緑 Green	567	CL-201G-C		48
		新緑 Fresh green	560	CL-201FG-C		48
		純緑 Pure green	557	CL-201PG-C		48
	高輝度 Super brightness	赤 Red	650	CL-201SR-C		48
		橙 Orange	630	CL-201SD-C		48
	超高輝度 Ultra brightness	赤 Red	660	CL-201UR-C		48
	超高輝度 High brightness	赤 Red	660	CL-201HR-C		48
		赤 Red	624	CL-201TR1-C		26
橙 Orange		612	CL-201TD3-C	26		
黄緑 Yellow green		574	CL-201SYG-C	26		
青緑 Blue Green		502	CL-201BG1-C	24		
<b>CL-221</b>  2.7(L) × 1.2(W) × 1.3(H)	標準輝度 Standard brightness	赤 Red	700	CL-221R-C	○	47
		橙 Orange	605	CL-221D-C		47
		黄 Yellow	589	CL-221Y-C		47
		黄緑 Yellow green	570	CL-221YG-C		47
		緑 Green	567	CL-221G-C		47
		新緑 Fresh green	560	CL-221FG-C		47
		純緑 Pure green	557	CL-221PG-C		47
	高輝度 Super brightness	赤 Red	650	CL-221SR-C		47
		橙 Orange	630	CL-221SD-C		47
	超高輝度 Ultra brightness	赤 Red	660	CL-221UR-C		47
	超高輝度 High brightness	赤 Red	660	CL-221HR-C		47
		赤 Red	624	CL-221TR1-C		26
橙 Orange		612	CL-221TD3-C	26		
黄緑 Yellow green		574	CL-221SYG-C	26		
青緑 Blue Green		502	CL-221BG1-C	24		

Series	Brightness	Lighting color	ピーク発光波長 Peak wave length(nm)	Code for parts	鉛フリー Lead free	Page
CL-260  3.4(L) × 1.25(W) × 1.1(H)	標準輝度 Standard brightness	赤 Red	700	CL-260R-CD	○	46
		橙 Orange	605	CL-260D-CD		46
		黄 Yellow	589	CL-260Y-CD		46
		黄緑 Yellow green	570	CL-260YG-X		46
		緑 Green	567	CL-260G-CD		46
		新緑 Fresh green	560	CL-260FG-CD		46
		純緑 Pure green	557	CL-260PG-CD		46
	高輝度 Super brightness	赤 Red	650	CL-260SR-CD		46
		橙 Orange	630	CL-260SD-CD		46
	超高輝度 Ultra brightness	赤 Red	660	CL-260UR-CD		46
	超高輝度 High brightness	赤 Red	660	CL-260HR-CD		46
		赤 Red	624	CL-260TR1-CD		26
		橙 Orange	612	CL-260TD3-CD		26
		黄緑 Yellow green	574	CL-260SYG-CD		26
		緑 Green	515	CL-260S-MG-D		24
		青緑 Blue Green	502	CL-260BG1-C		24
		青 Blue	470	CL-260HB1		24
青 Blue	470	CL-260S-MB-D	24			

Series	Brightness	Lighting color	ピーク発光波長 Peak wave length(nm)	Code for parts	鉛フリー Lead free	Page
CL-270  1.6(L) × 1.15(W) × 0.6(H)	標準輝度 Standard brightness	赤 Red	700	CL-270R-C	○	45
		橙 Orange	605	CL-270D-C		45
		黄 Yellow	589	CL-270Y-C		45
		黄緑 Yellow green	570	CL-270YG-C		45
		緑 Green	567	CL-270G-C		45
		新緑 Fresh green	560	CL-270FG-C		45
		純緑 Pure green	557	CL-270PG-C		45
	高輝度 Super brightness	赤 Red	650	CL-270SR-C		45
		橙 Orange	630	CL-270SD-C		45
	超高輝度 Ultra brightness	赤 Red	660	CL-270UR-C		45
	超高輝度 High brightness	赤 Red	660	CL-270HR-C		45
		赤 Red	624	CL-270TR1-C		26
		橙 Orange	612	CL-270TD3-C		26
		黄緑 Yellow green	574	CL-270SYG-C		26
		緑 Green	515	CL-270S-MG-D		24
		青緑 Blue Green	502	CL-270BG1-C		24
		青 Blue	470	CL-270HB1		24
青 Blue	470	CL-270S-MB-D	24			
CL-280  1.0(L) × 0.5(W) × 0.6(H)	標準輝度 Standard brightness	赤 Red	700	CL-280R-C	○	44
		橙 Orange	605	CL-280D-C		44
		黄 Yellow	589	CL-280Y-C		44
		黄緑 Yellow green	570	CL-280YG-C		44
		緑 Green	567	CL-280G-C		44
		新緑 Fresh green	560	CL-280FG-C		44
		純緑 Pure green	557	CL-280PG-C		44
	高輝度 Super brightness	赤 Red	650	CL-280SR-C		44
		橙 Orange	630	CL-280SD-C		44
	超高輝度 Ultra brightness	赤 Red	660	CL-280UR-C		44
	超高輝度 High brightness	赤 Red	660	CL-280HR-C		44

Series	Brightness	Lighting color	ピーク発光波長 Peak wave length (nm)	Code for parts	鉛フリー Lead free	Page
 CL-165 1.5(L) × 1.2(W) × 0.7(H)	標準輝度 Standard brightness	黄緑 Yellow green	570	CL-165HR/YG-D	○	43
		赤 Red	660			
 CL-375 2.4(L) × 1.0(W) × 1.35(H)	超高輝度 High brightness	黄緑 Yellow green	570	CL-375HR/YG	○	42
		赤 Red	660			
 CL-321 3.1(L) × 1.6(W) × 0.7(H)	標準輝度 Standard brightness	赤 Red	624	CL-321G	○	41
		緑 Green	515			
		青 Blue	470			
 CL-421 2.8(L) × 1.35(W) × 1.0(H)	超高輝度 High brightness	赤 Red	624	CL-421S-G	○	40
		緑 Green	515			
		青 Blue	470			
 CL-451 3.4(L) × 1.25(W) × 1.1(H)	超高輝度 High brightness	赤 Red	624	CL-451G	○	39
		緑 Green	515			
		青 Blue	470			
 CL-501 1.5(L) × 1.3(W) × 0.6(H)	超高輝度 High brightness	赤 Red	624	CL-501G	○	38
		緑 Green	515			
		青 Blue	470			

※ パッケージの色については未量産の機種もございますので、ご使用の際にはご確認願います。

※ Some package colors are not mass produced, so please check at the time of use.